

4 door controller TCP/IP/RFID weigand rfid access control board DH7004

DH-7004 TCP network access control panel is a device combined the most advanced chip technology and mechanics of communication. It can control 2 doors with 4 readers, bidirectional network control system. For each door, user can connect the controller with one reader for entry and one button for exit; or connect one reader for entry and one reader for exit to realize safer door access control request. Whenever required, the data stored in the controllers is transferred to the computer and activity reports are printed. Each controller works independently and keeps its own database.

Parameter	Single Door Control Panel	Multi Door (2) Control Panel	Multi Door (4) Control Panel
Model	DH-7001	DH-7002	DH-7004
Communication	TCP/IP 10M/100M adaotive	TCP/IP 10M/100M adaotive	TCP/IP 10M/100M adaotive
Description	Control 1 door, get in and out door by swiping card, of get in by swiping card and get out door by button	Control 2 door, get in and out door by swiping card, of get in by swiping card and get out door by button	Control 4 door, get in the door by swiping card, and get out door by button
Size of PCB board	160*106mm	160*106mm	160*106mm
Size of Case	273*228*65mm		
Power Supply	12VDC 4-7A		
Power Consumption of Circuit Board	Less than 100mA		
Input Format of Reader	Wiegand 26 (All card reader with compatible protocol. such as Motorola, HID, EM,, Mifare one etc)		
Quantity of Readers	2 pcs	4 pcs	4 pcs
Door Controlled	1 door	2 door	4 door

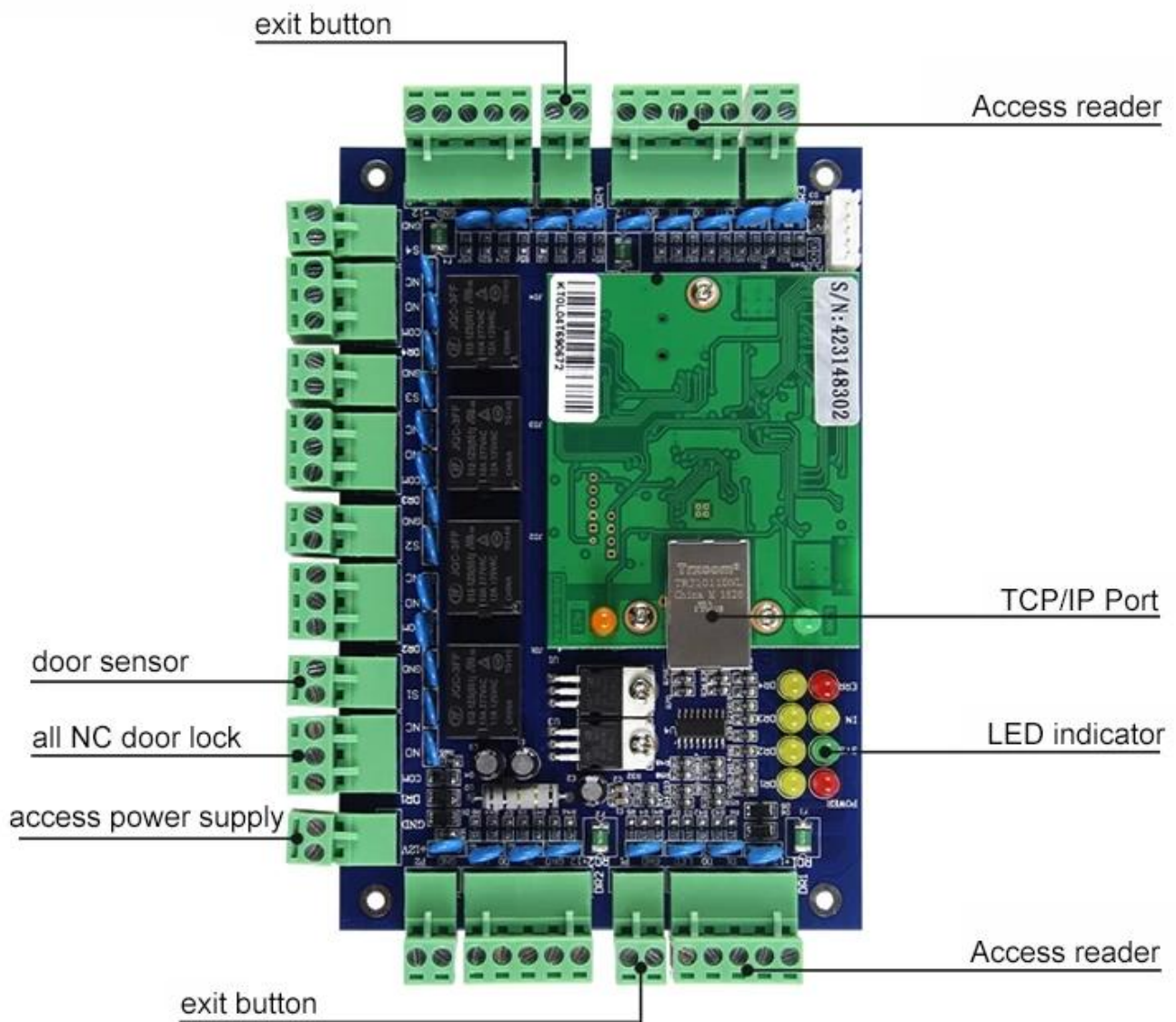

Features:

Support offline work, TCP/IP communication; allow direct connection with computer via network cable. Support LAN, remote control by PC software.

Compared to standard standalone access controller, this device separates the reader and the controller to individual parts so to realize higher safety request of your customer.

This device is compatible with all RF reader which is with any type of Wiegand standard communication format available in the market.

Wrong connection of reader or data cable will not destroy the device or unlock the door illegally.

Effect inhibition of static electricity and surge from input and feedback interference from electronic locks

All-in-one-card management system: normal shift and mult shifts time attendance management system; fixed ration dining management system; meeting attendance management system; online patrol management system and security alarm management system.





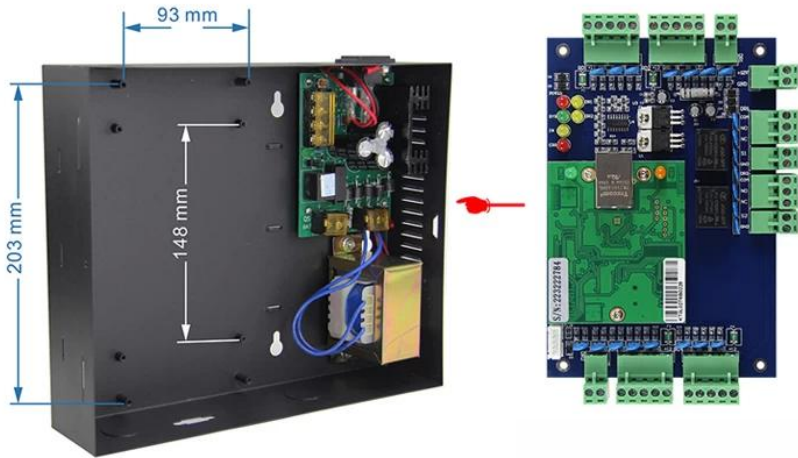
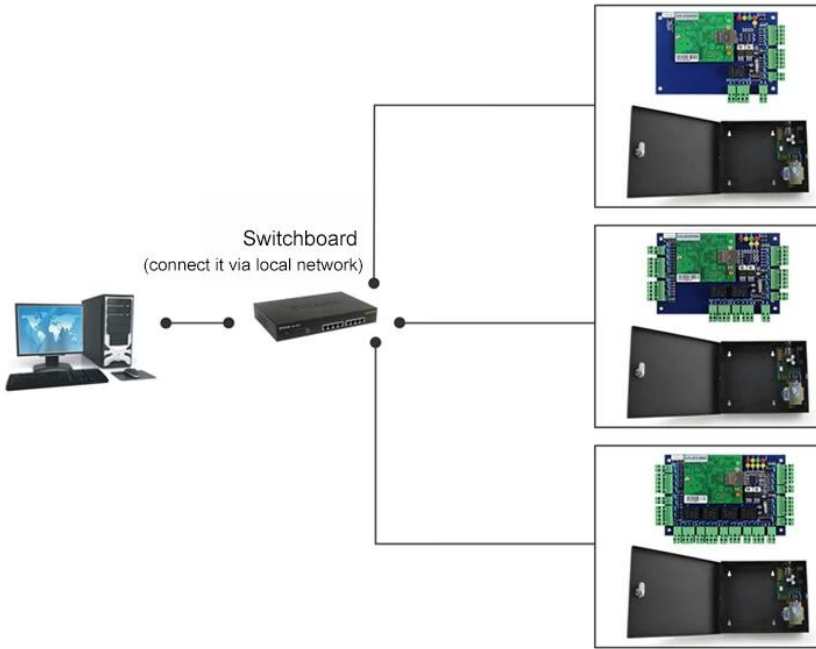

▶ Product Pictures:





Kindly remind:

All network control board must configure with access power supply.
1 board for 1 power supply

- 
RFID Reader
- 
Exit Button
- 
Electric Lock
- 
Power Supply
- 
Alarm and Fire Control
Expansion Panel
- 
Alarm

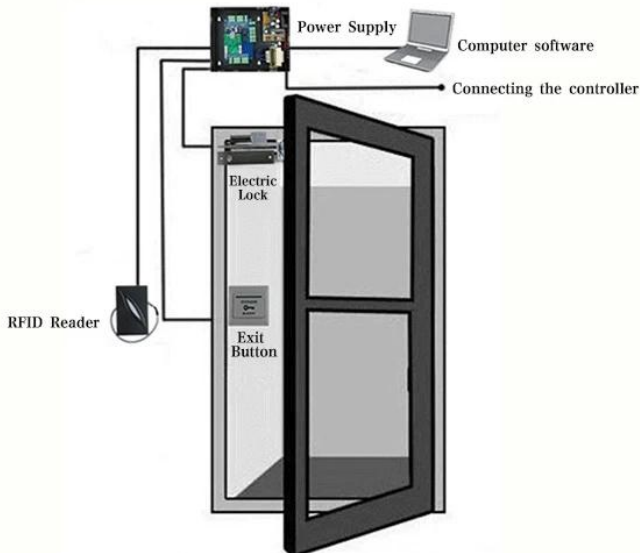

▶ Application:



**Networked
Security School**



**Networked
Security School**



**Standalone Access
Control Airport**



**Standalone Access
Control House**



**Time Attendance
Factory**



**Time Attendance
Office**

Access control management software also includes all-in-one-card management system such as normal shift and multi-shifts time attendance management system; fixed ration dining management system; meeting attendance management system.

Conventional Function: offline operation; real time supervision; photo display; mass storage; flexible user privilege setup; remote unlocking; multi-user supervision; quick setting; convenient checking and query; revisable and printable report form; report form; report can be exported to excel file; card+password unlocking; alarm for long time unclosing; alarm for invalid card swiping; first card unlocking; alarm for illegal break in; unlocking at definite time; e-map etc.

▶ About us



UDOHOW 鼎昊

Our company is a high-tech enterprise. We have been specialized in the R&D, production and marketing of Access Control Products. Products include Hotel Locks, Fingerprint Locks, Keypad Locks, Electromagnetic Locks, Electric Locks, Electric Bolt Locks, Power Supplies for Access Control, Access Controllers, Access Control Boards, Access Readers, RFID Cards, Exit Buttons and Switches, Time Attendance Access Controls, Door Closers, Fingerprint Access Controllers, and Cabinet Locks.



Products have Certification of CE, ROHS, FCC. From the lock - lock body - electronic board, UDOHOW masters the international advanced system lock technology and has a high quality assurance.



The company Upholds the business philosophy of **"Endless innovation, good faith forever"**, Because of the high quality of service, we have won the trust and support of our business friends. Our products are exported to the **United States, France, Spain, Russia, Singapore, Thailand, Turkey, Holland and other countries.**

